



Assembly Instruction

ITEM NO.:9212GRY-3L / 3R

Left Side 3-Seater with 1 Pillow & USB Port

Right Side 3-Seater with 1 Pillow & USB Port



Legs & hardware are stored at the bottom of seat, please take out the legs and hardware for assembly.

Note: Do not use power tools for assembly. Power tools increase the risk of over tightening which lead to splitting or cracking the wood.

Component list .

Label	Picture	Description	QTY (pc)	Label	Picture	Description	QTY (pc)
A		Left Side 3-Seater	1	F		Side Back Cushion	5
B		Right Side 3-Seater	1	G		LSF Back Cushion	1
C		Wooden Leg 5"*5"*2 3/4"	8	H		RSF Back Cushion	1
D		Middle wooden Leg 2 2/5"*2 2/5"*2 3/5"	2	I		Power Cord	2
E		Pillow	2				

STEP1

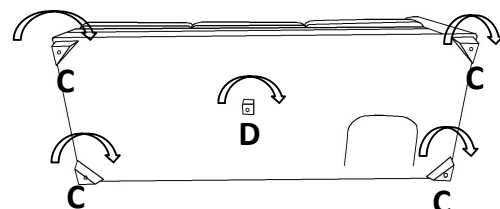
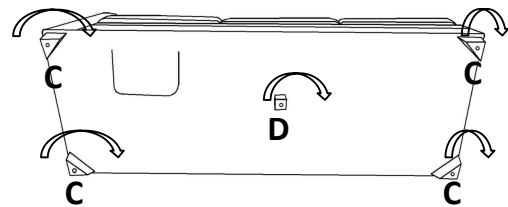
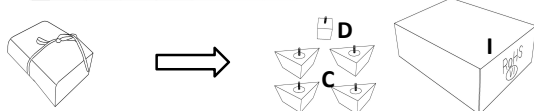
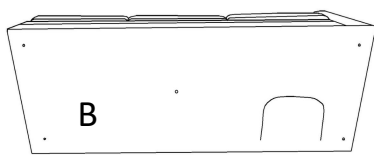
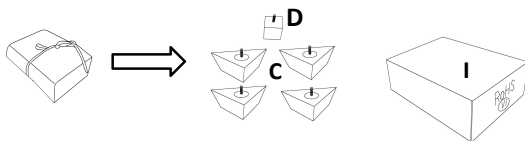
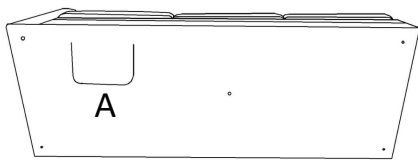

STEP2

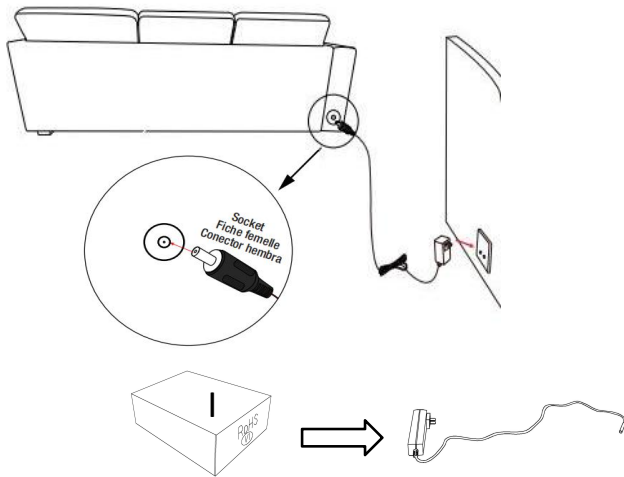
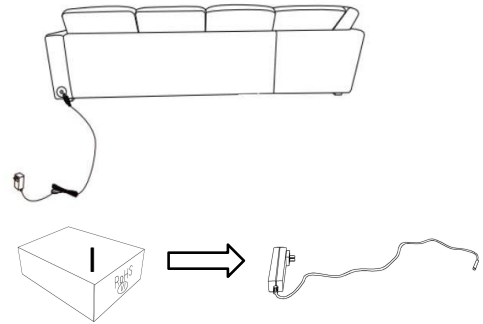
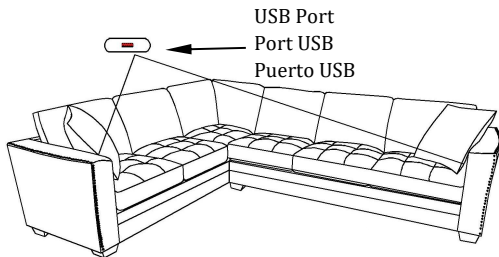
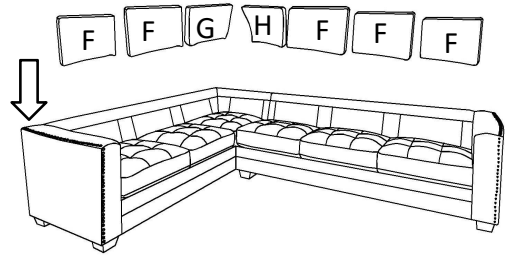
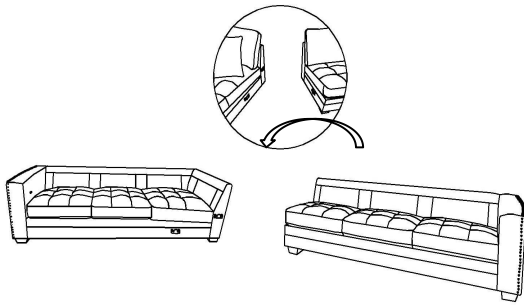

STEP3: Assembly Completed

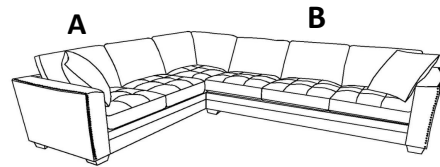

Care Instruction for Texture Fabric Furniture:

In order to maintain the original appearance of your texture fabric Furniture, please follow below simple care procedures:

- Avoid exposing furniture directly to sunlight or heating and air conditioning outlets. Sunlight and or exposure to heating and air conditioning outlets will fade/damage Texture Fabric.
- Vacuum or wipe with a soft cloth to remove dust.



For items use on wooden floor, hard surfaces or carpets, it is recommended to Install protective pads under all legs and supports to avoid/prevent from damages/scratches and discoloration.

Warning

Do not allow electrical cord to be pinched between moving parts or between the frame and the floor.
Do not place cord under carpet or in location where it could become worn.