









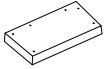

# ASSEMBLY INSTRUCTION

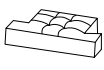
ITEM NO: 9367 DGY-1N Chair

 Legs and hardware are stored in the box, please take out for assembly.

NOTE: Do not use power tools for assembly. Power tools increase the risk of over tightening which lead to splitting or cracking the wood.

## CHAIR COMPONENT LIST

NO.	DRAWING	QTY	DESCRIPTION
A		1	SEAT
B		1	BACKREST
C		1	LSF ARM
D		1	SEAT CUSHION
E		1	BACK CUSHION
F		4	PLASTIC LEG 4"* 4"*3.15"
G		6	FLAT WASHER Ø5/16"
H		6	NUT Ø5/16"
I		6	BOLT Ø5/16" *3.6"
K		6	WRENCH
L		4	PLASTIC WASHER Ø1.75"
M		1	RSF ARM

### Step 1

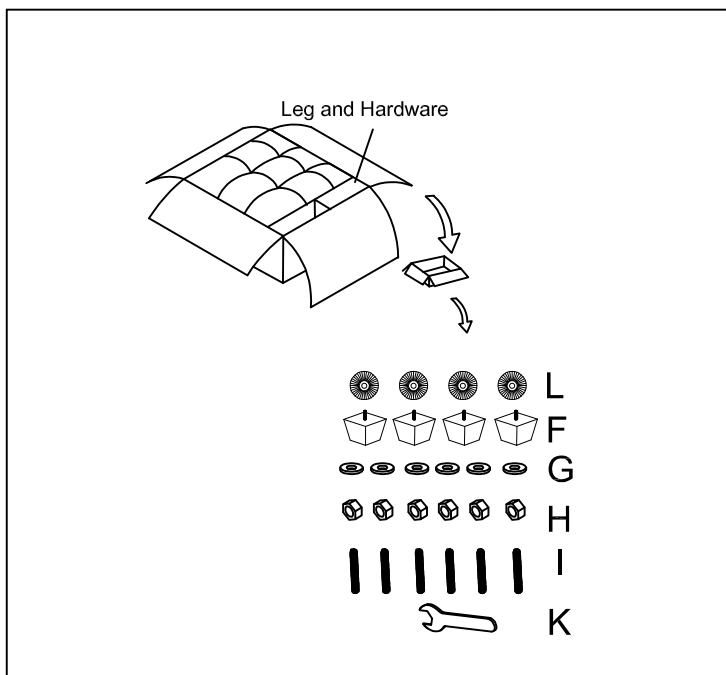

### Step 2

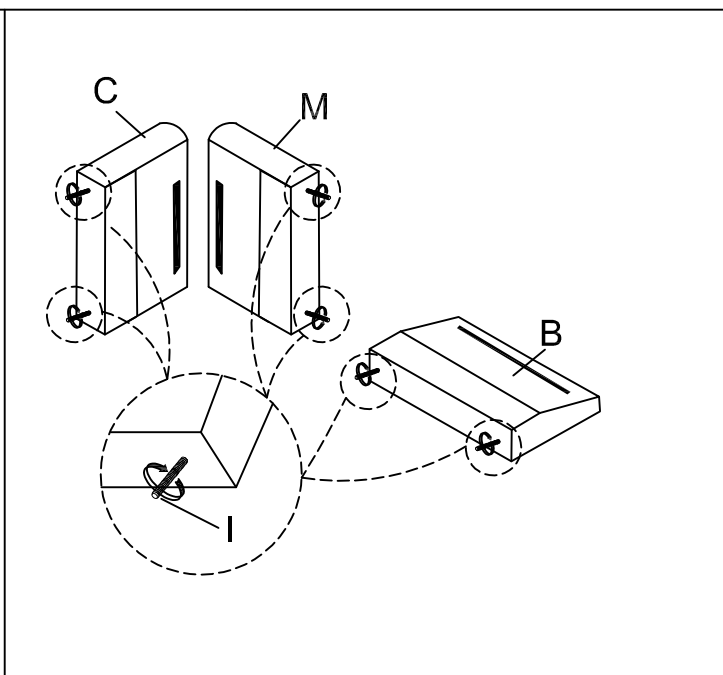

### Step 3

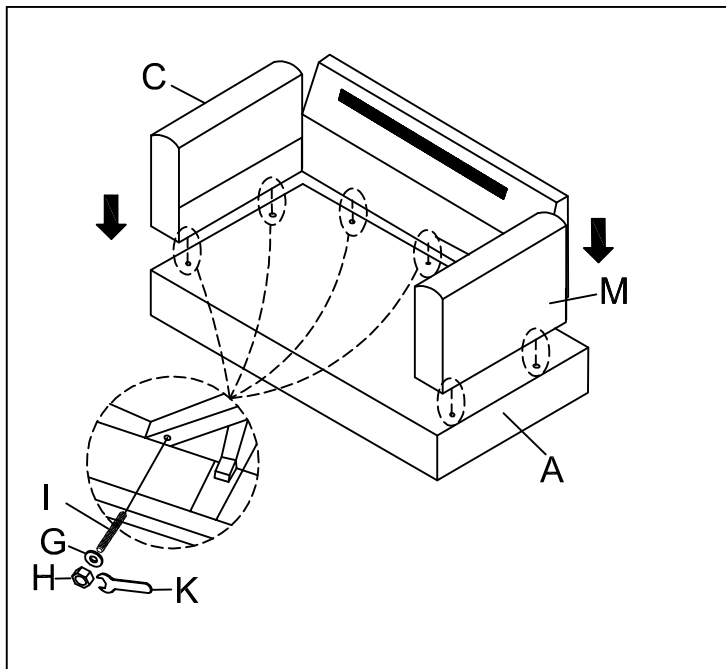

### Step 4

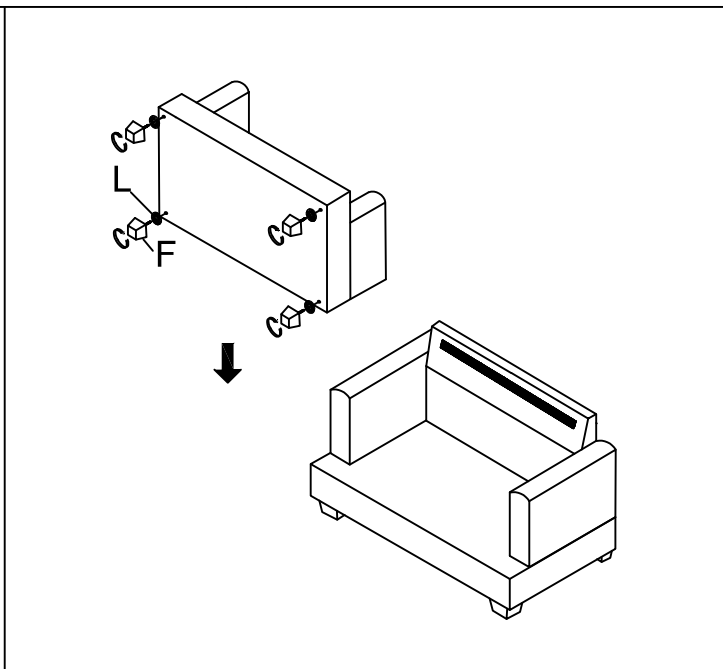

## Step 5

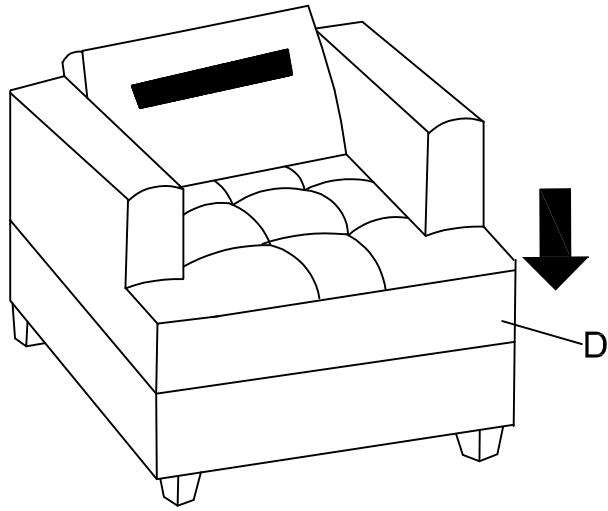

## Step 6

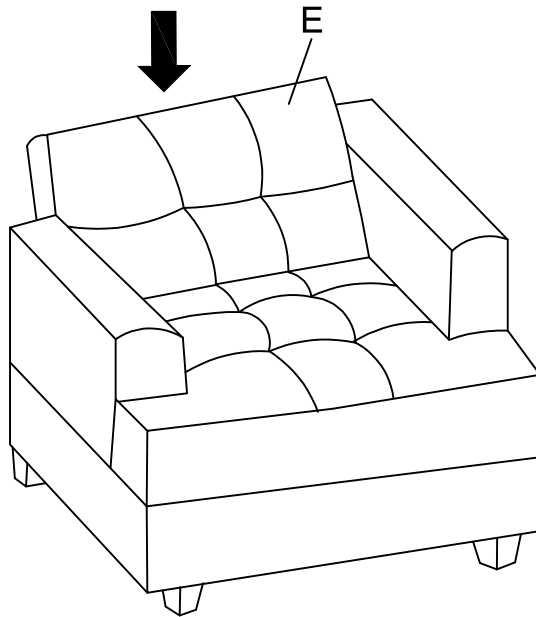

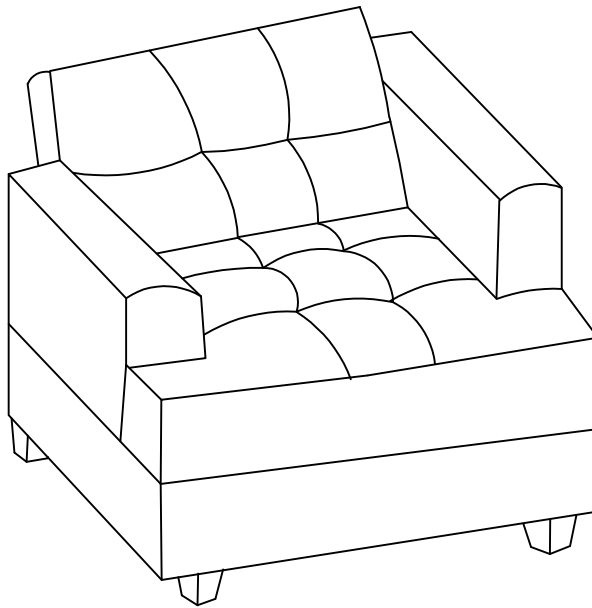

## **CARE INSTRUCTIONS FOR TEXTURED UPHOLSTERY FURNITURE:**

In order to maintain the original appearance of your textured furniture, please follow below care procedures:

- Avoid exposing furniture directly to sunlight or heating and air conditioning outlets. Sunlight and / or exposure to heating and air conditioning outlets will fade/damage textured . Do not place your upholstered furniture too close to windows, radiators, or vents, and be sure to use window treatments to block the sun's rays.
- Vacuum or wipe with a soft cloth regularly to remove dust.



For items use on wooden floor, hard surfaces or carpets, it is recommended to Install protective pads under all legs and supports to avoid/prevent from damages/scratches and discoloration.